

# SHARP SERVICE MANUAL

CODE : 00ZERA520USME

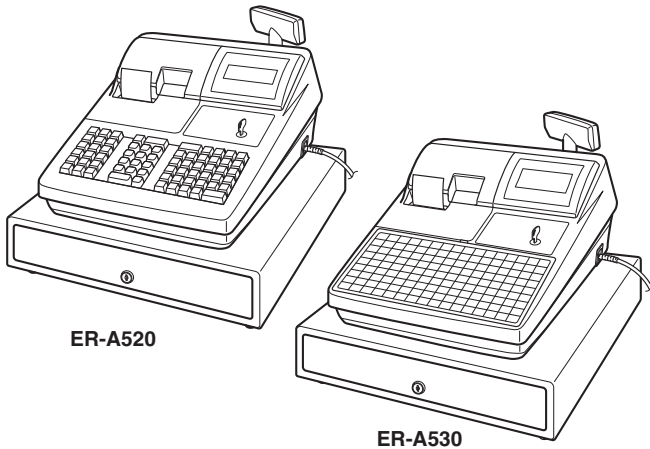

## ELECTRONIC CASH REGISTER

### ER-A520 MODEL ER-A530 (U, A version)

#### CONTENTS

CHAPTER 1. SPECIFICATIONS .....	1
CHAPTER 2. OPTIONS .....	5
CHAPTER 3. MASTER RESET AND PROGRAM RESET.....	6
CHAPTER 4. HARDWARE DESCRIPTION .....	7
CHAPTER 5. DIAGNOSTIC PROGRAM .....	14
CHAPTER 6. IPL FROM EP-ROM .....	19
CHAPTER 7. CIRCUIT DIAGRAM AND PWB LAYOUT .....	20
PARTS GUIDE	

Parts marked with "△" are important for maintaining the safety of the set. Be sure to replace these parts with specified ones for maintaining the safety and performance of the set.

# CHAPTER 1. SPECIFICATIONS

## 1. APPEARANCE

### ER-A520

#### ■ Front view

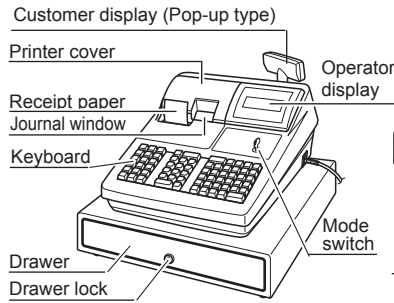

#### ■ Rear view

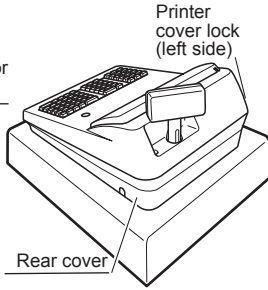

### ER-A530

#### ■ Front view

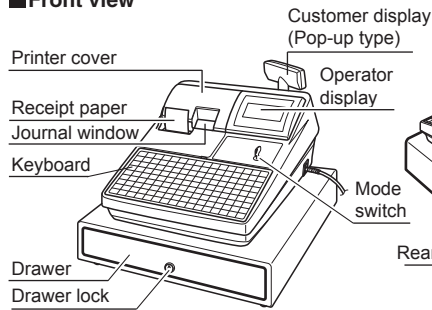

#### ■ Rear view

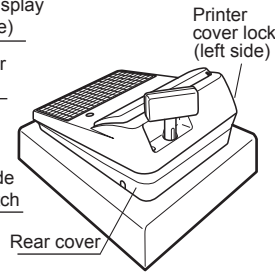

## 2. RATING

Model	ER-A520/530
Weight	31.7lbs (14.4kg)
Dimensions	421 (W) x 427 (D) x 297 (H) mm 16.6 (W) x 16.8 (D) x 11.7 (H) inch
Power source	120V ±10%, AC 60Hz
Power consumption	Stand-by 11W, Operating 47W (max.)
Working temperature	0°C~40°C (32°F to 104°F)

## 3. KEYBOARD

### 3-1. KEYBOARD LAYOUT

#### ER-A520

Type	Normal keyboard
Key stroke	3.5 ± 0.5 mm
Key pitch	19 (W) x 19 (H) mm

#### ER-A530

Type	Flat key
Key stroke	0.8 ± 0.2 mm
Key pitch	18 (W) x 15 (H) mm

### 3-2. KEY LAYOUT

#### ER-A520

##### ■ STANDARD KEY LAYOUT

↑ RECEIPT	↑ JOURNAL	NC	CASH#	PLU/UPC	PRICE CHANGE	AMT	INQ	FS SHIFT	AUTO 1	
SLIP	RCPT	PBLU	@/FOR	• CL	5	10	20	FS TEND	AUTO 2	
CONV	RA	FINAL	7	8	4	9	14	19	NS	CH1
%1	PO	TAX	4	5	3	8	13	18	CHK	CH2
%2	⊖	TAX SHIFT	1	2	2	7	12	17	MDSE SBTL	SBTL
RFND	VOID	#/TM	0	00	1	6	11	16	CA/AT	

##### ■ TEXT PRESET KEY LAYOUT

↑ RECEIPT	↑ JOURNAL	(NUM)	(DC)	⊘ ∞	(Back Space)
(v)	(^)	@/FOR	• CL	" A " F # K \$ P % U & X	
(.)	(-)	7	8	' B * G @ L / Q ( V ) Y	
(.)	(.)	4	5	: C : H ' M . R ! W ? Z	
(^)	(^)	1	2	+ D - I = N ⊘ S	
(SHIFT)	(SHIFT-2)	(SPACE)	0	< E > J Pt O £ T	

Note: All keys except the receipt paper feed and journal paper feed keys can be re-positioned.

##### ■ Standard Key names and Descriptions

↑ RECEIPT	Receipt paper feed key
↑ JOURNAL	Journal paper feed key
[0]~[9], [00]	Numeric keys
[.]	Decimal point key
CL	Clear key
@/FOR	Multiplication key
RFND	Refund key
VOID	Void key
AMT	Amount entry key
CASH#	Cashier code entry key
PLU/UPC	PLU/UPC key
INQ	PLU/UPC inquiry key
PRICE CHANGE	UPC price change key
⊖	Discount 1 key
%1, %2	Percent 1 and 2 keys
NC	New check key
PBLU	Previous balance key
FINAL	Final key
NS	No-sale key
TAX SHIFT	TAX 1 shift key
TAX	Manual tax key
MDSE SBTL	Merchandise subtotal key
1 ~ 20	Department keys
AUTO1~AUTO2	Automatic sequencing 1 and 2 keys
RA	Received-on-account 1 key
PO	Paid-out 1 key
FS SHIFT	Food stamp shift key
FS TEND	Food stamp tender key
CH1, CH2	Charge 1and 2 keys
CONV	Currency conversion key
CHK	Check 1 key
SBTL	Subtotal key
CA/AT	Cash/Amount tendered key
RCPT	Receipt print key

SLIP	Slip printer key
#/TM	Non-add code/Date & time display key

Note: The following function keys can optionally be incorporated in place of those shown in the figure of the standard keyboard layout. Fo

■ **Optional Key Names and Descriptions**

DEPT#	Dept. number key
%3 ~ %5	Percent 3 thru 5 keys
⊖ 2 ~ ⊖5	Discount 2 thru 5 keys
CH3 ~ CH9	Charge 3 thru 9 keys
CA2 ~ CA5	Cash 2 thru 5 keys
CONV2 ~ CONV4	Currency conversion 2 thru 4 keys
RA2	Received-on-account 2 key
PO2	Paid-out 2 key
AUTO3 ~ AUTO10	Automatic sequencing 3 thru 10 keys
SRVC	Service key
TRAY SBTL	Tray subtotal key
RETURN	Return key
CHK2~CHK5	Check 2 through 5 keys
TRANS OUT	Transfer out key
TRANS IN	Transfer in key
CA TIP	Cash tip key
CH TIP	Charge tip key
TIP PAID	Tip paid key
EAT IN1~EAT IN3	Eat in 1 thru 3 keys
TAX2 SHIFT~TAX4 SHIFT	Tax 2 thru 4 shift keys
DEPO	Deposit key
DEPORFND	Deposit refund key
LEVEL#	PLU level shift number key
RP SEND	Remote printer send key
GRT EXEMPT	Gratuity exempt key
OPEN TARE	Tare entry key
REPEAT	Repeat entry key
GASSBTL	Gasoline sales subtotal key
P-SHIFT#	Price shift number key
SCALE	Scale entry key
L1~L5	PLU level shift 1 thru 5 keys
P1~P6	Price level shift 1 thru 6 keys
PRINT	Validation print key
CVCNT	Cover count entry key
NO DEL	No delete key
BS	Bill separation key
BT	Bill totalize/Bill transfer key (CHECK-ADD)
BIRTH	Birthday entry key
RFND SALES	Refund sales key
WASTE	Waste mode key
C NEXT	Condiment next key
C CANCEL	Condiment cancel key
EDIT TIP	Edit tip key
GLU RECALL	Table# recall key
000	Numeric key

Note: The department and direct PLU keys may be expanded.

**ER-A530**

■ **STANDARD KEY LAYOUT**

↑ RECEIPT	↑ JOURNAL	91	92	93	94	95	96	97	98	99	100	L1	L2	L3	AUTO 1
79	80	81	82	83	84	85	86	87	88	89	90	RCPT	%	⊖	AUTO 2
67	68	69	70	71	72	73	74	75	76	77	78	VOID	INQ	RP SEND	AUTO 3
56	57	58	59	60	61	62	63	64	65	66	SERV #	RFND	PLU/SUB	NC	CONV
45	46	47	48	49	50	51	52	53	54	55	@/FOR	•	CL	PBAL	CH1
34	35	36	37	38	39	40	41	42	43	44	7	8	9	SRVC	CH2
23	24	25	26	27	28	29	30	31	32	33	4	5	6	FINAL	CH3
12	13	14	15	16	17	18	19	20	21	22	1	2	3	MDSE SBTL	CHK
1	2	3	4	5	6	7	8	9	10	11	0	00	000	SBTL	CA/AT

■ **TEXT PRESET KEY LAYOUT**

↑ RECEIPT	↑ JOURNAL	←	→	↶	↷	Ñ	¿	{	}	[	]				[BACK (SPACE)]
		↓	↓	“	”	'	?	<	>						
!	@	#	\$	%	^	&	*	(	)	=					
1	2	3	4	5	6	7	8	9	0	-	+				
Q	W	E	R	T	Y	U	I	O	P	/	@/FOR	•	CL		
A	S	D	F	G	H	J	K	L	.	:	7	8	9		
	Z	X	C	V	B	N	M	,	.	_	4	5	6		
(SHIFT)	(DC)	(SPACE)	(SPACE)	(SPACE)	(SPACE)	(SPACE)					1	2	3		
											0	00	000	SBTL	CA/AT

Note: • All keys except the receipt paper feed and journal paper feed keys may be re-positioned.

• Please note that the Price lookup/subdepartment/UPC key ([PLU/SUB]) and the previous balance key ([PBAL]) are shown as [PLU/UPC] and [PBLU] respectively in this manual. PLU/UPC PBAL

■ **Standard Key Names and Descriptions**

↑ RECEIPT	Receipt paper feed key
↑ JOURNAL	Journal paper feed key
[0] ~ [9], [00], [000]	Numeric keys
[.]	Decimal point key
CL	Clear key
@/FOR	Multiplication key
RCPT	Receipt print key
RFND	Refund key
VOID	Void key
PLU/SUB	Price lookup/subdepartment/UPC key
[1] ~ [100]	Direct price lookup keys
L1~L3	PLU level shift 1 thru 3 keys
NC	New check key
SRVC	Service key
FINAL	Final key
PBAL	Previous balance key
⊖	Discount 1 key
%	Percent 1 key
INQ	PLU/UPC inquiry key
SERV#	Server code entry key
AUTO1 ~ AUTO3	Automatic sequencing 1 thru 3 keys
CONV	Currency conversion key
CH1 ~ CH3	Charge 1 thru 3 keys
CHK	Check 1 key
MDSE SBTL	Merchandise subtotal key
SBTL	Subtotal key
CA/AT	Cash/amount tendered key
RP SEND	Remote printer send key

Note: The following function keys can optionally be added in place of those shown in the figure of the standard keyboard layout.

■ **Optional Keys and Descriptions**

DEPT#	Dept. number key
%2 ~ %5	Percent 2 thru 5 keys
⊖ 2 ~ ⊖5	Discount 2 thru 5 keys
CH4 ~ CH9	Charge 4 thru 9 keys
CA2 ~ CA5	Cash 2 thru 5 keys
CONV2 ~ CONV4	Currency conversion 2 thru 4 keys
RA1, RA2	Received-on-account 1 and 2 keys
PO1, PO2	Paid-out 1 and 2 keys
AUTO4 ~ AUTO10	Automatic sequencing 4 thru 10 keys
CHK2 ~ CHK5	Check 2 through 5 keys
TRANS OUT	Transfer out key
TRANS IN	Transfer in key
CA TIP	Cash tip key
CH TIP	Charge tip key
TIP PAID	Tip paid key
EAT IN1 ~ EAT IN3	Eat in 1 thru 3 keys
TAX1 SHIFT ~ TAX4 SHIFT	Tax 1 thru 4 shift keys
DEPO	Deposit key
DEPO RFND	Deposit refund key
TAX	Manual tax key
TRAY SBTL	Tray subtotal key
RETURN	Return key
GAS SBTL	Gasoline sales subtotal key
#/TM	Non-add code/Date & time display key
NS	No-sale key
SCALE	Scale entry key
LEVEL#	PLU level shift number key
L4, L5	PLU level shift 4 and 5 keys
P-SHIFT#	Price shift number key
P1 ~ P6	Price level shift 1 thru 6 keys
PRINT	Validation print key
CV CNT	Cover count entry key
SLIP	Slip printer key
BS	Bill separation key
BT	Bill totalize/Bill transfer key (CHECK-ADD)
NO DEL	No delete key
GRT EXEMPT	Gratuity exempt key
OPEN TARE	Tare entry key
REPEAT	Repeat entry key
AMT	Amount entry key
PRICE CHANGE	UPC price change key
BIRTH	Birthday entry key
RFND SALES	Refund sales key
WASTE	Waste mode key
C NEXT	Condiment next key
C CANCEL	Condiment cancel key
EDIT TIP	Edit tip key
GLU RECALL	Table# recall key
FS SHIFT	Food stamp shift key
FS TEND	Food stamp tender key

Note: Department and direct PLU keys can be expanded.

## 4. MODE SWITCH

### 4-1. MODE SWITCH AND MODE KEYS

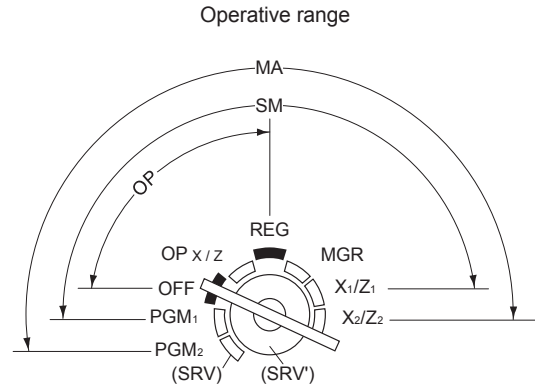

• Manager key (MA)

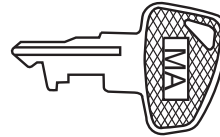

• Submanager key (SM)

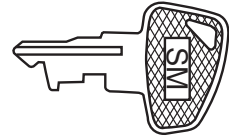

• Operator key (OP)

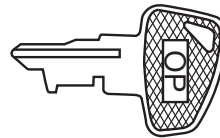

The mode switch has these settings:

- OFF:** This mode locks all register operations. No changes may occur to register data.
- OP X/Z:** This setting allows cashiers to take an X or Z reports for their sales information. This mode can also be used for displaying the date/time and printing the employee's arrival/departure times. This mode can be also used to toggle receipt state "ON" and "OFF" by pressing the [RCPT] key. (To utilize this function, the register must be programmed for "OP X/Z mode available" in the PGM2 mode.)
- REG:** For entering sales
- PGM1:** To program those items that need to be changed often: e.g., unit prices of departments or PLUs, and percentages.
- PGM2:** To program all PGM1 programs and those items that do not require frequent changes: e.g., date, time, or a variety of register functions.
- MGR:** For manager's and submanager's entries  
The manager can use this mode to make entries that are not permitted to be made by cashiers in the REG mode.  
– for example, after-transaction voiding and override entries.
- X1/Z1:** To take the X/Z reports for various daily totals.
- X2/Z2:** To take the X/Z reports for various periodic (weekly or monthly) consolidation of totals.

## 5. DISPLAY

### 5-1. OPERATOR DISPLAY

Display device: LCD  
 Number of lines: 2 lines  
 Number of positions: 16 positions  
 Color of display: Yellow / Green  
 Character font: 5 x 7 dot  
 Character size: 4.84 (W) x 8.06 (H) mm

**Layout:**

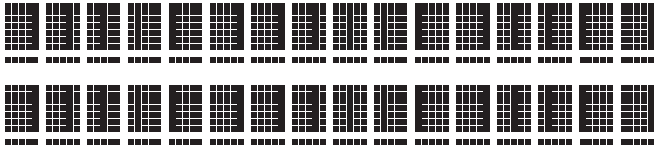

### 5-2. CUSTOMER DISPLAY

Display device: LED  
 Number of lines: 1 line  
 Number of positions: 7 positions  
 Color of display: Yellow / Green  
 Style: Pop up type  
 Character form: 7 segment + decimal point  
 Character size: 14.2mm (H) x 7.9mm (W)

**Layout:**



## 6. PRINTER

### 1) PRINTER (PR-58HM)

Item	Description
No. of station	2: Receipt and Journal
Validation	No
Printing system	Line thermal
No. of dot	Receipt: 360 dots Journal: 360 dots
Dot pitch	Horizontal: 0.125mm Vertical: 0.125mm
Font	10 dots (W) x 24 dots (H)
Printing capacity	Receipt: Max. 30 characters Journal: Max. 30 characters
Character size	1.25 mm (W) x 3.0 mm (H): At 10 x 24 dots
Print pitch	Column distance: 1.5 mm Row distance: 3.75 mm
Paper feed speed	Approximate 65 mm/s
Reliability	Mechanism: MCBF 5million lines
Paper end sensor	Yes (Receipt and Journal)
Cutter	Manual
Paper near end sensor	No
Printing area	
Printing format	

### 2) PAPER

Item	Description
Name	Heat-quality paper
Roll dimension	57.5 ± 0.5 mm in width
Thickness	0.06 mm to 0.08 mm

## 7. DRAWER

### [OUTLINE]

- Standard equipment: Yes
- Max. number of additional drawers: 1
- The drawer consists of:
  - 1) Drawer box (outer case) and drawer
  - 2) Money case
  - 3) Lock (attached to the drawer)

### [SPECIFICATION]

#### 7-1. DRAWER BOX AND DRAWER

Model name of the drawer box	SK423
Size	420 (W) x 427 (D) x 112 (H) mm
color	Gray 368
Material	Metal
Bell	-
Release lever	Standard equipment: <b>located on the bottom</b>
Drawer open sensor	YES

#### 7-2. MONEY CASE

	For U version	For A version
Separation from the drawer	Allowed	Allowed
Separation of the coin compartments from the money case	Disallowed	Allowed
Bill separator	No	No
Number of compartments	5B/5C	5B/6C

For U version

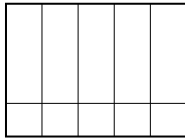

5B/5C

For A version

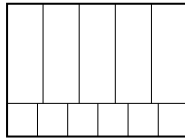

5B/6C

#### 7-3. LOCK (LOCK KEY: LKGIM7331BHZZ)

- Location of the lock: Front
- Method of locking and unlocking:
 

To lock, insert the drawer lock key into the lock and turn it 90 degrees counter clockwise.

To unlock, insert the drawer lock key and turn it 90 degrees clockwise.

Key No: SK1-1

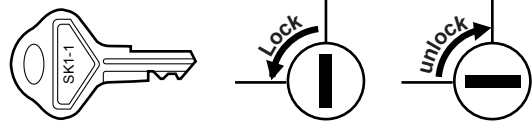

## CHAPTER 2. OPTIONS

### 1.OPTIONS

NO	CLASSIFICATION	COMPONENT NAME	MODEL NAME	REMARK
1	Drawer	Remote drawer	ER-03DW	
			ER-04DW	
2	Key kit	1 x 1 key top kit (30)	ER-11KT7	ER-A520 only
		1 x 2 key top kit (30)	ER-12KT7	
		2 x 2 key top kit (10)	ER-22KT7	
		1 x 1 dummy key kit (30)	ER-11DK7G	
		5 x 1 dummy key kit (10)	ER-51DK7G	
3	Display	<b>Customer Pole Display</b>	UP-P16DP	
4	Memory	RAM board	UP-S02MB	

# CHAPTER 3. MASTER RESET AND PROGRAM RESET

The SRV key is used for performing entries in the SRV mode.

A MASTER RESET clears the entire memory and resumes initial values.

A PROGRAM RESET resumes the initial program without clearing the memory.

There are 2 kinds of MASTER RESET operations.

MASTER RESET 1: Normal MASTER RESET  
Clears the entire memory and resumes initial values.

MASTER RESET 2: It enables the layout of fixed keys in addition to MASTER RESET 1.

Fixed keys: [0] [1] [2] [3] [4] [5] [6] [7] [8] [9]  
[00] [000] [.] [CL] [ @/FOR ] [SBTL]  
[CA/AT]

## 1. MASTER RESET 1

Please use "Procedure A" or "Procedure B"

Procedure A: 1) Set the mode switch to the (SRV') position.  
2) Plug in the AC power cord to the wall outlet.  
3) While holding down the JOURNAL FEED key, turn the mode switch to (SRV) position from the (SRV') position.

Procedure B: 1) Unplug the AC power cord from the wall outlet.  
2) Set the mode switch to the (SRV) position.  
3) While holding down the JOURNAL FEED key, plug in the AC power cord to the wall outlet.

Note: Procedure B cannot reset the hardware.  
Procedure A must be used to reset the hardware.

## 2. MASTER RESET 2

Please use "Procedure A" or "Procedure B"

Procedure A: 1) Set the mode switch to the (SRV') position.  
2) Plug in the AC power cord to the wall outlet.  
3) While holding down the JOURNAL FEED & the RECEIPT FEED keys, turn the mode switch to the (SRV) position from the (SRV') position.  
4) Program the [0] [1] [2] [3] [4] [5] [6] [7] [8] [9] [00] [000] [.] [CL] [ @/FOR ] [SBTL] [CA/AT] keys by depressing the keys in this order.

Note: If the [000] key is not required, press the same key in the next step, and the [000] key will be inhibited.

Procedure B: 1) Unplug the AC power cord from the wall outlet.  
2) Set the mode switch to the (SRV) position.  
3) While holding down the JOURNAL FEED & the RECEIPT FEED key, plug in the AC power cord to the wall outlet.  
4) Repeat the same sequence as in "Procedure A"

Note: Procedure B cannot reset the hardware.  
Procedure A must be used to reset the hardware.

## 3. PROGRAM RESET

Please use either "Procedure A", "Procedure B" or "Procedure C"

Procedure A: 1) Set the mode switch to the (SRV') position.  
2) Plug in the AC power cord to the wall outlet.  
3) Without pressing the JOURNAL FEED key, turn the mode switch to (SRV) position from the (SRV') position.

Procedure B: 1) Unplug the AC power cord from the wall outlet.  
2) Set the mode switch to the (SRV) position.  
3) Without pressing the JOURNAL FEED key, plug in the AC power cord from the wall outlet.

Procedure C: 1) Unplug the AC power cord from the wall outlet.  
2) Set the mode switch to the PGM2 position.  
3) While holding down the JOURNAL FEED key & the RECEIPT FEED key, plug in the AC power cord to the wall outlet.

\*"Procedure C" can be executed when SRV#916-B is +4: PROGRAM RESET in PGM2 = ENABLE.

Note: Procedure B and C cannot reset the hardware.  
Procedure A must be used to reset the hardware.

# CHAPTER 4. HARDWARE DESCRIPTION

## 1. BLOCK DIAGRAM

ER-A520 and ER-A530

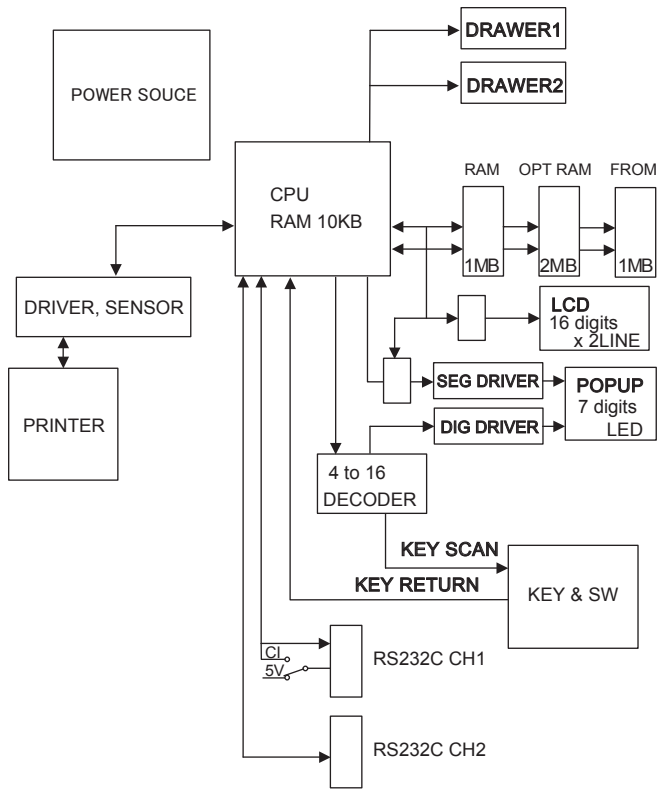

- CPU
  - MITSUBISHI M30802GP 12MHz
  - (INTERNAL RAM 10KB)
- EXTERNAL MEMORY
  - STD RAM 1MB
  - OPT RAM 2MB
  - FLASH ROM 1MB
- PRINTER
  - PR58HM

## 2. MEMORY MAP

### 2-1. ADDRESS MAP

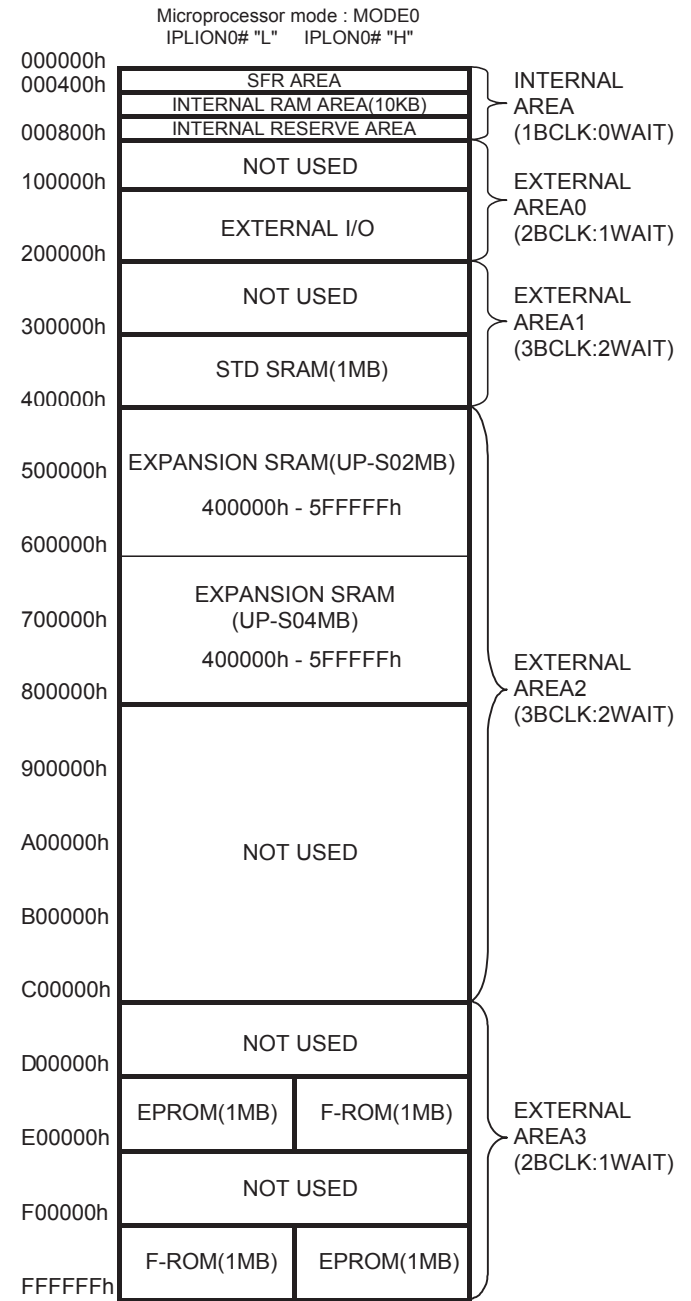

### 3. CPU PIN TABLE

M16C/80 PORT

USED IN PROCESSOR MODE: MICROPROCESSOR MODE (SEPARATE BUS 8bit WIDTH)

PORT	PIN No.	Pin name	Signal name	I/O	Initial value	After POFF	Function
P00	122	D0	D0	I/O	–	In	DATA BUS D0
P01	121	D1	D1	I/O	–	In	DATA BUS D1
P02	120	D2	D2	I/O	–	In	DATA BUS D2
P03	119	D3	D3	I/O	–	In	DATA BUS D3
P04	113	D4	D4	I/O	–	In	DATA BUS D4
P05	112	D5	D5	I/O	–	In	DATA BUS D5
P06	111	D6	D6	I/O	–	In	DATA BUS D6
P07	110	D7	D7	I/O	–	In	DATA BUS D7
P10	109	P10	RAS	O	L	Out L	RECEIPT PAPER FEED A
P11	108	P11	RBS	O	L	Out L	RECEIPT PAPER FEED B
P12	107	P12	RCS	O	L	Out L	RECEIPT PAPER FEED C
P13	106	P13	RDS	O	L	Out L	RECEIPT PAPER FEED D
P14	105	P14	JAS	O	L	Out L	JOURNAL PAPER FEED A
P15	104	P15 /INT3#	JBS	O	L	Out L	JOURNAL PAPER FEED B
P16	103	P16 /INT4#	JCS	O	L	Out L	JOURNAL PAPER FEED C
P17	102	P17 /INT5#	JDS	O	L	Out L	JOURNAL PAPER FEED D
P20	101	A0	A0	O	–	Out L	Address Bus A0
P21	100	A1	A1	O	–	Out L	Address Bus A1
P22	99	A2	A2	O	–	Out L	Address Bus A2
P23	98	A3	A3	O	–	Out L	Address Bus A3
P24	97	A4	A4	O	–	Out L	Address Bus A4
P25	96	A5	A5	O	–	Out L	Address Bus A5
P26	95	A6	A6	O	–	Out L	Address Bus A6
P27	94	A7	A7	O	–	Out L	Address Bus A7
P30	92	A8	A8	O	–	Out L	Address Bus A8
P31	85	A9	A9	O	–	Out L	Address Bus A9
P32	84	A10	A10	O	–	Out L	Address Bus A10
P33	83	A11	A11	O	–	Out L	Address Bus A11
P34	82	A12	A12	O	–	Out L	Address Bus A12
P35	81	A13	A13	O	–	Out L	Address Bus A13
P36	80	A14	A14	O	–	Out L	Address Bus A14
P37	79	A15	A15	O	–	Out L	Address Bus A15
P40	78	A16	A16	O	–	Out L	Address Bus A16
P41	77	A17	A17	O	–	Out L	Address Bus A17
P42	75	A18	A18	O	–	Out L	Address Bus A18
P43	73	A19	A19	O	–	Out L	Address Bus A19
P44	72	A20 /CS3#	A20	O	–	Out L	Address Bus A20
P45	71	A21 /CS2#	A21	O	–	Out L	Address Bus A21
P46	70	A22 /CS1#	A22	O	–	Out L	Address Bus A22

PORT	PIN No.	Pin name	Signal name	I/O	Initial value	After POFF	Function
P47	69	A23# /CS0#	A23#	O	–	Out L	Address Bus A23
P50	65	WR#	WR#	O	–	Out L	WRITE STROBE SIGNAL
P51	64	BHE#	BHE#	O	–	Out L	NOT USED
P52	63	RD#	RD#	O	–	Out L	READ STROBE SIGNAL
P53	62	BCLK	BCLK	O	–	Out L	BCLK CLOCK
P54	55	HLDA#	HLDA#	O	–	Out L	NOT USED
P55	54	HOLD#	HOLD#	I	–	In	NOT USED
P56	53	ALE	ALE	O	–	Out L	NOT USED
P57	52	RDY#	RDY#	I	–	In	NOT USED
P60	47	RTS0#	RS2#	O	H	In	RS-232 RS2
P61	46	CLK0	CI2#	I	–	In	RS-232 CI2
P62	45	RxD0	RD2	I	–	In	RS-232 RD2
P63	44	TxD0	TD2	O	H	In	RS-232 TD2
P64	43	RTS1#	RS1#	O	H	In	RS-232 RS1
P65	42	CLK1	CI1#	I	–	In	RS-232 CI1
P66	40	RxD1	RD1	I	–	In	RS-232 RD1
P67	38	TxD1	TD1	O	H	In	RS-232 TD1
P70	37	P70/ TA0out	KR0#	I	–	In	KEY RETURN SIGNAL 0
P71	36	P71/ TA0in	KR1#	I	–	In	KEY RETURN SIGNAL 1
P72	35	P72/ TA1out	KR2#	I	–	In	KEY RETURN SIGNAL 2
P73	34	P73/ TA1in	KR3#	I	–	In	KEY RETURN SIGNAL 3
P74	33	P74/ TA2out	KR4#	I	–	In	KEY RETURN SIGNAL 4
P75	32	P75/ TA2in	KR5#	I	–	In	KEY RETURN SIGNAL 5
P76	31	P76/ TA3out	KR6#	I	–	In	KEY RETURN SIGNAL 6
P77	30	P77/ TA3in	KR7#	I	–	In	KEY RETURN SIGNAL 7
P80	29	P80/ TA4out	BUZZER	O	L	In	BUZZER SIGNAL
P81	28	P81/ TA4in	DSEN	I	–	In	DRAWER OPEN SENSE SIGNAL
P82	27	P82/ INT0#	POFF#	I	–	In	P-OFF SIGNAL
P83	26	P83 /INT1#	SHEN#	I	–	In	UP-P16DP SHEN# SIGNAL
P84	25	P84 /INT2#		I	–	In	NOT USED
P85	24	P85 /NMI#	NMI#	I	–	In	NMI (CONNECTED TO VDD)
P86	18	P86/ Xcout	Xcout	O	–	Out	SUB CLOCK (32.768kHz)
P87	17	P87/ Xcin	Xcin	I	–	In	SUB CLOCK (32.768kHz)
P90	7	P90/ CLK3	SCK	O	L	Out L	UP-P16DP CLOCK SIGNAL

PORT	PIN No.	Pin name	Signal name	I/O	Initial value	After POFF	Function
P91	6	P91/RxD3	STH	I	–	In	UP-P16DP STH SIGNAL
P92	5	P92/TxD3	HTS	O	L	Out L	UP-P16DP HTS SIGNAL
P93	4	P93/RTS3#	DRAWER1	O	L	Out L	DRAWER 1 DRIVE SIGNAL
P94	3	P94/RTS4#	DRAWER2	O	L	Out L	DRAWER 2 DRIVE SIGNAL
P95	2	P95/CLK4	PCLK	O	L	Out L	PRINTER CLOCK
P96	1	P96/TxD4	SO	O	L	Out L	PRINTER DATA OUT
P97	144	P97/RxD4	SI	I	–	In	PRINTER DATA IN
P100	141	P100/AN0	TM	I	–	In	PRINTER HEAD TEMPERATURE MONITOR
P101	139	P101/AN1	VPTEST	I	–	In	PRINTER HEAD VOLTAGE MONITOR
P102	138	P102/AN2	VREF	I	–	In	REFERENCE VOLTAGE
P103	137	P103/AN3	PHUPS	I	–	In	PRINTER HEAD UP DETECTION
P104	136	P104/AN4	RPES	I	–	In	PRINTER RECEIPT PAPER EMPTY DETECTION
P105	135	P105/AN5	JPRS	I	–	In	PRINTER JOURNAL PAPER EMPTY DETECTION
P106	134	P106/AN6	VHCOM	O	L	Out L	PRINTER POWER CONTROL
P107	133	P107/AN7		I	–	In	NOT USED
P110	118	P110	STRB1#	O	H	In	PRINTER STROBE 1
P111	117	P111	STRB2#	O	H	In	PRINTER STROBE 2
P112	116	P112	STRB3#	O	H	In	PRINTER STROBE 3
P113	115	P113	STRB4#	O	H	In	PRINTER STROBE 4
P114	114	P114	LATCH#	O	H	In	PRINTER LATCH
P120	90	P120	BLON	O	L	Out L	LCD BACK LIGHT ON
P121	89	P121	LCDON	O	L	Out L	LCD POWER ON
P122	88	P122	LRS	O	L	Out L	LCD RS
P123	87	P123	LR/W#	O	L	Out L	LCD R/W#
P124	86	P124	LE	O	L	Out L	LCD ENABLE
P125	68	P125	LWDL	O	L	Out L	LCD WRITE DATA LATCH
P126	67	P126	IPLON0	I	–	In	IPL from ROM
P127	66	P127		O	–	Out L	NOT USED
P130	61	P130	ER2#	O	H	In	RS-232 ER2
P131	60	P131	CD2#	I	–	In	RS-232 CD2
P132	58	P132	CS2#	I	–	In	RS-232 CS2
P133	56	P133	DR2#	I	–	In	RS-232 DR2

PORT	PIN No.	Pin name	Signal name	I/O	Initial value	After POFF	Function
P134	51	P134	ER1#	O	H	In	RS-232 ER1
P135	50	P135	CD1#	I	–	In	RS-232 CD1
P136	49	P136	CS1#	I	–	In	RS-232 CS1
P137	48	P137	DR1#	I	–	In	RS-232 DR1
P140	14	P140	KR8#	I	–	In	KEY RETURN SIGNAL 8
P141	13	P141	KR9#	I	–	In	KEY RETURN SIGNAL 9
P142	12	P142	MODE#	I	–	In	MODE KEY RETURN SIGNAL
P143	11	P143	FSR#	I	–	In	FEED SENSE SIGNAL
P144	10	P144	WP#	I	–	In	Flash ROM WP#
P145	9	P145	RY/BY#	I	–	In	NOT USED
P146	8	P146	CKDCR	O	H	In	UP-P16DP RESET SIGNAL
P150	131	P150	KS0	O	L	Out L	KEY STROBE SIGNAL 0
P151	129	P151	KS1	O	L	Out L	KEY STROBE SIGNAL 1
P152	128	P152	KS2	O	L	Out L	KEY STROBE SIGNAL 2
P153	127	P153	KS3	O	L	Out L	KEY STROBE SIGNAL 3
P154	126	P154	LEDS0	O	L	Out L	LED STROBE SIGNAL 0
P155	125	P155	LEDS1	O	L	Out L	LED STROBE SIGNAL 1
P156	124	P156	LEDS2	O	L	Out L	LED STROBE SIGNAL 2
P157	123	P157	LEDS3	O	L	Out L	LED STROBE SIGNAL 3

#### POWER SUPPLY/CONTROL PINS

PORT	PIN No.	I/O	PIN NAME	FUNCTION
Xin	22	I	Xin	SYSTEM CLOCK IN
Xout	20	O	Xout	NC
RESET#	19	I	RESET#	RESET
BYTE	15	I	BYTE	Connected to VDD
CNVss	16		CNVss	Connected to VDD
Vref	142		Vref	Connected to VDD

## 4. PRINTER CONTROL

The PR-58HM printer is **incorporated**.

### 4-1. STEPPING MOTOR CONTROL

The stepping motor is driven at a constant current by SMA7036M (made by Sanken).

1step: 0.125mm, 1dot: 1step

Printing speed: 50mm/s

#### <CPU PORT>

No.	CPU PORT	Signal to be used
109	P10	RAS
108	P11	RBS
107	P12	RCS
106	P13	RDS
105	P14	JAS
104	P15	JBS
103	P16	JCS
102	P17	JDS

#### <DRIVING STEP>

##### RECEIPT MOTOR

STEP	Driver IC input (CPU output)				Motor drive signal			
	RAS	RBS	RCS	RDS	/RPFA	/RPFB	/RPFC	/RPFD
1	L	H	L	H	ON	OFF	ON	OFF
2	L	H	H	L	ON	OFF	OFF	ON
3	H	L	H	L	OFF	ON	OFF	ON
4	H	L	L	H	OFF	ON	ON	OFF

STEP	Driver IC input (CPU output)				Motor drive signal			
	JAS	JBS	JCS	JDS	/JPFA	/JPFB	/JPFC	/JPFD
1	L	H	H	L	ON	OFF	OFF	ON
2	L	H	L	H	ON	OFF	ON	OFF
3	H	L	L	H	OFF	ON	ON	OFF
4	H	L	H	L	OFF	ON	OFF	ON

\*When the motor is stopped, rush conduction must be performed for 10ms in the same phase as the last excitation phase to turn off conduction to all the phases.

→ RAS~RDS and JAS~JDS are turned to "L".

Allow at least 30ms before boosting after stopping.

When boosting, rush conduction must be performed for 10ms in the first excitation phase to start the motor by acceleration control.

### 4-2. HEAD CONTROL

HEAD: All864dot

Printable area: RECEIPT side, 360dot;  
JOURNAL side, 360dot

#### Related PORT

No.	CPU PORT	Signal to be used
2	P95/CLK2	PCLK
1	P96/TXD4	SO
144	P97/RXD4	SI
118	P110	STRB1#
117	P111	STRB2#
116	P112	STRB3#
115	P113	STRB4#

STB1#: 1~288dot: 288 dots in all  
 STB2#: 289~432dot: 144 dots in all  
 STB3#: 433~576dot: 144 dots in all  
 STB4#: 577~864dot: 288 dots in all

} Total 864 dots

\*When turning off the printer power supply, make sure to turn /STB1,2,3,4 to "H."

\*Do not turn on the printer under paper empty state.

\*During printing or paper feeding, after 10ms of turning on the printer head power, A/D conversion must be performed to check that the voltage is stabilized before starting the operation.

### 4-3. OTHER PORTS

No.	CPU PORT	Signal to be used
136	P103	PHUPS
135	P104	PRES
134	P105	PJES
133	P106	VHCOM

PHUPS: "1" Head up

PRES : "0" Receipt paper end

PJES : "0" Journal paper end

VHCOM: "1" Thermal head power control: On at "H" and OFF at "L".

Turn off the power conduction when printing is completed (the motor is stopped).

## 5. A/D CONVERSION

In the ER-A520/530, the following three kinds of signals are **input** to the A/D conversion port.

### <CPU PORT>

No.	CPU PORT	Signal to be used	Function
130	AN0	TM	PRINTER HEAD TEMPERATURE MONITOR
138	AN1	VPTEST	PRINTER HEAD VOLTAGE MONITOR
137	AN2	VREF	REFERENCE VOLTAGE

### 5-1. PRINTER HEAD TEMPERATURE MONITOR

A voltage divided by the temperature detection thermistor of the printer head and the resistor is **input** to AN0 pin.

The printer head conduction must be controlled as shown below.

HEAD TEMPERATURE	A/D CONVERSION VALUE (DEC)	OPERATION
-10°C or below	929~1023	MOTOR LOCK
-10°C ~ 0°C	869~928	PRINT IN ENERGIZING TIME AT 0°C
0°C ~ 70°C	232~868	PRINT FOR CONDUCTION TIME SPECIFIED ON PR-58H CONTROL SPEC.
70°C or above	0~231	MOTOR LOCK

### 5-2. PRINTER HEAD VOLTAGE MONITOR

The voltage is supplied by the printer head power source, passed through the printer, and divided by the resistor is inputted to AN1 pin.

The A/D conversion value must be read after turning VHCOM signal (CPU P106) to "H" and stabilizing the voltage (after 10msec).

The printable voltage range of the printer is 15V~26V. The voltage is calculated from the AN1 value and the A/D conversion value of the reference voltage.

### 5-3. REFERENCE VOLTAGE

The reference voltage (2.495V±0.085V) generated by KIA431F is **supplied** to AN2 pin.

$$469 \text{ (DEC)} \leq VREF \leq 557 \text{ (DEC)}$$

VREF 469 (DEC) corresponds to VREF = 2.41V at VCC = 5.25V

VREF 557 (DEC) corresponds to VREF = 2.58V at VCC = 4.75V

## 6. KEY/DISPLAY

### 6-1. LCD CONTROL

The LCD control is same as the ER-A275P.

#### LCD-related Register

Function	Address	R/W
LCD Write Data	100001h	W
LCD Read Data	100001h	R

### <CPU PORT>

No.	CPU PORT	Signal to be used	Function
90	P120	BLON	LCD BACK LIGHT ON SIGNAL
89	P121	LCDON	LCD ON SIGNAL
88	P122	LRS	LCD RS SIGNAL
87	P123	LR/W#	LCD R/W# SIGNAL
86	P124	LE	LCD E SIGNAL
85	P125	DATALE	LCD WRITE DATA LATCH

P125: LWDL  
L : LCD write data latch

P124: E  
Enable Signal  Enable

P123: R/W#  
H: Data read L: Data Write

P122: LRS  
H: Data input L: Instruction Input

#### DATA WRITE (CPU → LCD)

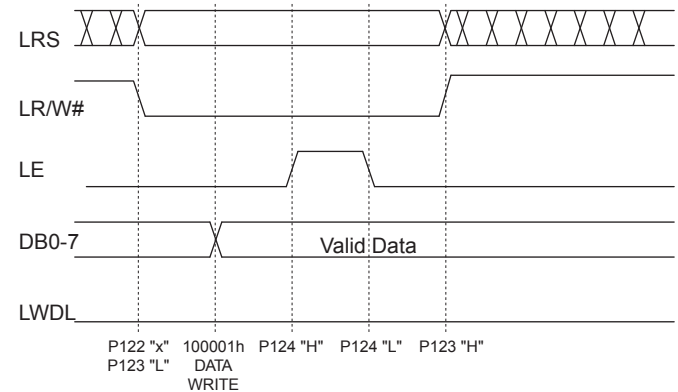

#### DATA READ (CPU ← LCD)

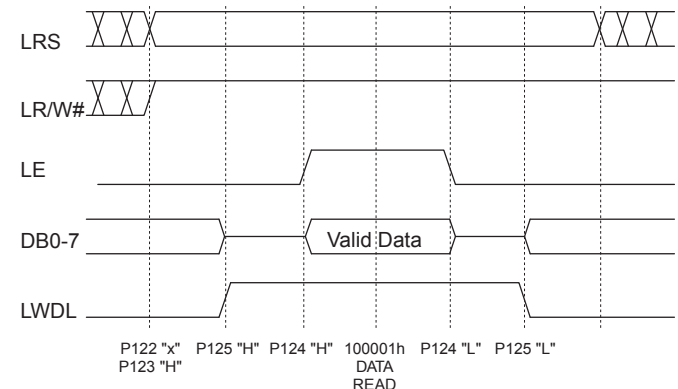

When the read busy flag of the LCD display remains busy for more than 500ms, the LCDON (P121) is turned off for 1ms and initialization is performed.

## 6-2. KEY/DISPLAY SCAN

The Key/display scan and key read are performed at the following timing.

- ① Key/display scan cycle: 10ms
- ② Blanking time: 50us
- ③ KEY DATA READ timing: Read before 10~100us of strobe signal OFF.

### Key/Display-related Register

Function	Address	R/W
LED Segment Signal	100000h	W

### <LED Segment Signal> Write

Address	Bit7	Bit6	Bit5	Bit4	Bit3	Bit2	Bit1	Bit0
100000h	DP	g	f	e	d	c	B	a

### <CPU PORT>

No.	CPU PORT	Signal to be used	Function
131	P150	KS0	KEY STROBE SIGNAL 0
129	P151	KS1	KEY STROBE SIGNAL 1
128	P152	KS2	KEY STROBE SIGNAL 2
127	P153	KS3	KEY STROBE SIGNAL 3
126	P154	LS0	LED STROBE SIGNAL 0
125	P155	LS1	LED STROBE SIGNAL 1
124	P156	LS2	LED STROBE SIGNAL 2
123	P157	LS3	LED STROBE SIGNAL 3

KS3~0 : KEY strobe signal is generated.

LS3~0 : POP UP Display strobe signal is generated.

No.	CPU PORT	Signal to be used	Function
46	P70	KR0#	KEY RETURN SIGNAL 0
45	P71	KR1#	KEY RETURN SIGNAL 1
44	P72	KR2#	KEY RETURN SIGNAL 2
43	P73	KR3#	KEY RETURN SIGNAL 3
42	P74	KR4#	KEY RETURN SIGNAL 4
41	P75	KR5#	KEY RETURN SIGNAL 5
40	P76	KR6#	KEY RETURN SIGNAL 6
39	P77	KR7#	KEY RETURN SIGNAL 7
14	P140	KR8#	KEY RETURN SIGNAL 8
13	P141	KR9#	KEY RETURN SIGNAL 9

R0#~KR9# : Flat Keyboard KEY Return signal

KR0#~KR7# : Normal Keyboard KEY Return signal

No.	CPU PORT	Signal to be used	Function
12	P142	MODE#	MODE KEY SIGNAL
11	P143	FSR#	FEED SENS SIGNAL

The mode key switch and other signals are read at CPU ports P142 and P143 at the key strobe timing.

Reading is made 10~100us before the strobe signal OFF..

P142	ST0 :	MODE Key SRV	"0" SRV mode
	ST1 :	MODE Key PGM	"0" PGM mode
	ST2 :	MODE Key VOID	"0" VOID mode
	ST3 :	MODE Key OP X/Z	"0" OP X/Z mode
	ST4 :	MODE Key REG	"0" REG mode
	ST5 :	MODE Key MGR	"0" MGR mode
	ST6 :	MODE Key X1/Z1	"0" X1/Z1 mode
	ST7 :	MODE Key X2/Z2	"0" X2/Z2 mode

P143	ST10 :	Receipt feed	"0" Receipt feed
	ST11 :	Journal feed	"0" Journal feed
	ST13 :	Keypad select	"1" Flat key "1" JNormal key

The Flat Keyboard takes key data in twice during the strobe period.  
For read timing, refer to the timing chart below.

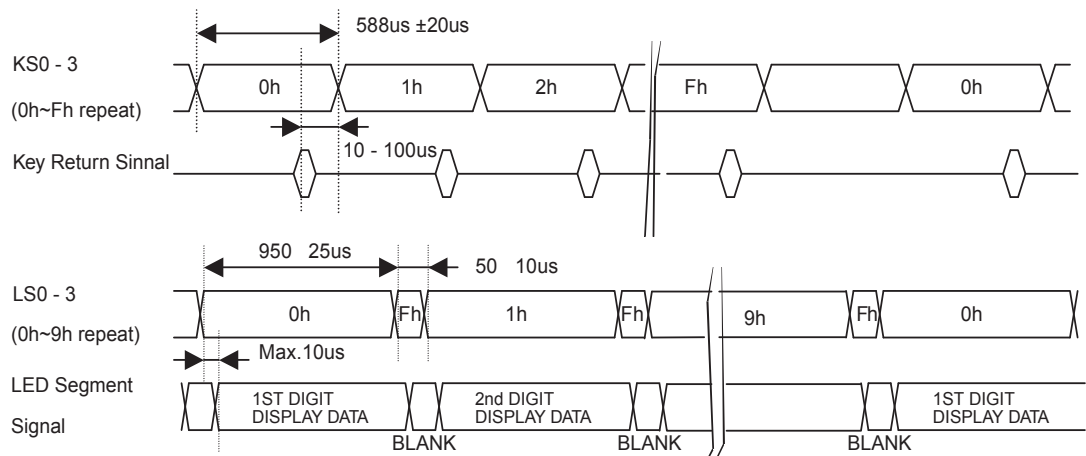

### 6-3. DISPLAY

The ER-A520/530 is provided with the LCD display of 5 x 7 dot, 2 line, 16 digit on the **operator** side, and the LED display of 7 digit on the **customer** side.

#### Operator (Front):

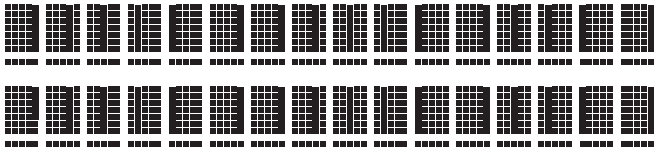

#### Customer (Pop up Type):



- DISPLAY DIGIT SIGNAL

The above ST0~ST6 are DIGIT signals.

ST0:1st digit~ST6:7th digit

- DISPLAY SEGMENT SIGNAL

The LED segment signal can be outputted by writing segment data to 4000h.

DATA~SEGMENT assignment

D0~D6 → a~g

D7 → DP

## 7. SERIAL I/O

The ER-A520/530 is provided with **2 each** RS-232 ports **standard**

The **Ch1** and Ch2 of RS-232 are assigned to the following CPU ports.

#### Ch1

Pin No.	CPU PORT	Signal to be used
42	/RTS1#	RS1#
41	P65	CI1#
40	RXD1	RD1
39	TxD1	SD1
51	P134	ER1#
50	P135	CD1#
49	P136	CS1#
48	P137	DR1#

#### Ch2

Pin No.	CPU PORT	Signal to be used
47	/RTS0#	RS2#
46	P61	CI2#
45	RXD0	RD2
44	TxD0	SD2
61	P130	ER2#
60	P131	CD2#
58	P132	CS2#
56	P133	DR2#

## 8. POWER

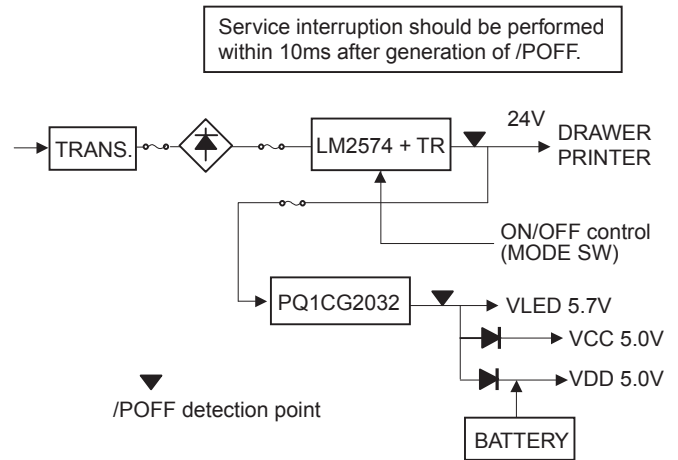

## 9. FLASH MEMORY REWRITE PROCEDURE

The Fujitsu MBM29F800TA-90 Flash ROM is incorporated.

No.	CPU PORT	Signal to be used	Function
67	P126	IPLON0	IPL from EP-ROM
66	P127	IPLON1	IPL from COM
10	P144	WP#	F ROM Write Protect signal
9	P145	RY/BY#	F ROM Ready/Busy signal

IPLON0# : "1"; IPL from EP-ROM. Executed from ER ROM.

IPLON1# : "1"; IPL from COM

WP#: Not used in the ER-A520/530

RY/BY# : Ready/Busy signal from the FLASH ROM

IPL from EPROM : After setting the IPL SW to the ON side, turn on the AC power to start the update from the EPROM.

IPL from COM : Data from PC are written into the FLASH ROM through the COM port. (Max. 38.4kbps)

## 10. DRAWER

The ER-520/530 is provided with **2 drawer ports**.

The drive time of the drawer solenoid is as follows:

50ms (max) 45ms(min)

#### <CPU PORT>

No.	CPU PORT	Signal to be used	Function
4	P93	DRAWER1	DRAWER1 OPEN SIGNAL
3	P94	DRAWER2	DRAWER2 OPEN SIGNAL
28	P81	DSEN	DRAWER OPEN SIGNAL

DRAWER1 : "1", DRAWER 1 OPEN

DRAWER2 : "1", DRAWER 2 OPEN

DSEN : "1", DRAWER OPEN

## 11. RISTRCTIONS ON PRINT RATIO

Max. 288dot/1line x 140line (Corresponds to black background LOG print)

Ave. 108dot/1line or less (Corresponds to 12.5% of all dots)

## 12. BUZZER

Oscillation frequency is 2.048kHz (2.0kHz~2.2kHz).

### <CPU PORT>

No.	CPU PORT	Signal to be used	Function
29	P80	BUZZER	BUZZER SIGNAL

## 13. UP-P16DP I/F

The ER-A520/530 is provided with I/F with CKDC on the option display of UP-P16DP.

### <CPU PORT>

No.	CPU PORT	Signal to be used	Function
26	INT1#	SHEN#	CKDC interface shift enable signal
7	CLK3	SCK	CKDC interface synchronizing shift clock
6	RxD3	STH	CKDC interface shift input data
5	TxD3	HTS	CKDC interface shift output data
8	P126	CKDCR	CKDC reset signal

The CKDCR "HIGH" time to input RESET to the UP-P16DP is min 30us.

## 14. RESET

The RESET signal is generated under the following condition.

- 1) When the MODE key switch position is changed from SRV' to any other position (excluding OFF position).

## 15. POFF

The POFF signal is changed from 0 to 1 when the 5V power and the 24V power reach the operating voltage level.

It is changed from 0 to 1 when the power falls below the operating voltage level.

### POFF, RESET TIMING CHART

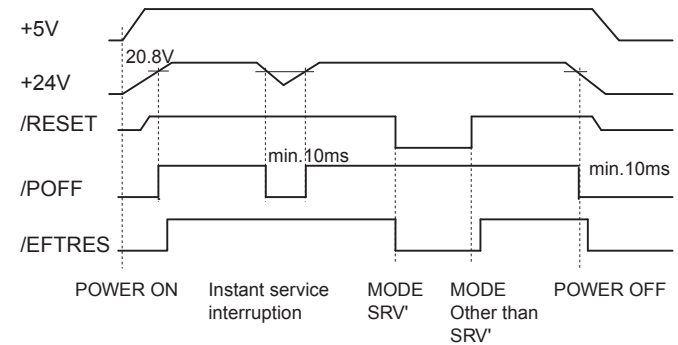

# CHAPTER 5. DIAGNOSTIC PROGRAM

## 1. TEST ITEMS

The test items are as follows:

	Code	Description
1)	100	Display buzzer test
2)	101	Key code
3)	102	Printer test
4)	104	Keyboard test
5)	105	Mode switch test
6)	106	Printer sensor test
7)	107	Clock test
8)	110	Drawer 1 open & sensor test
9)	111	Drawer 2 open & sensor test
10)	116	LCD CG test
11)	120	Standard RAM test
12)	121	OPTION RAM test
13)	122	CPU internal RAM test
14)	130	FLASH ROM test
15)	160	AD conversion port test
16)	400	POLE DISPLAY test
17)	500	RS232 ch1 test
18)	501	RS232 ch2 test
19)	510	SCANNER test

\*Starting DIAG.

Mode switch: SRV

key operation: Above code + "CA/AT" key

## 2. DESCRIPTION OF EACH DIAG PROGRAM

### 1) DISPLAY BUZZER TEST

① Key operation

100 → CA/AT

② Test procedure

OP display

D	I	S	P		B	U	Z	Z	E	R		S	R	V	
0	1	2	3	4	5	6	7	8	9	A	B	C	D	E	F

Rear display

4.5.6.7.8.9.0.

The decimal point on the LED and the cursor on the LCD will shift from the lower digit to the upper digit in steps of 1 digit (every 200 msec)

After that, all segments will turn on (about 1 sec)

These two modes are repeated.

At the same time, the buzzer sounds continuously.

③ Check that:

A) Each position is correctly displayed.

B) The brightness of each number is uniform.

C) The buzzer sound is normal.

④ End of testing

You can exit the test mode by pressing any key. The following is printed.

**1 0 0**

### 2) KEY CODE

① Key operation

101 → CA/AT

② Test procedure

OP display

K	E	Y		C	O	D	E					S	R	V	
○												○	○	○	

KEYBOARD

KEY CODE

③ Check that:

KEYBOARD: 1: Normal type 0: Flat type

KEY code: Every time a key is pressed, the hard code of that key is displayed as a decimal number.

When a key is pressed twice or pressed in an incorrect manner, --- will be displayed.

④ End of testing

You can exit the test mode by turning the mode switch to a position other than the PGM mode. The printer prints as follows:

**1 0 1**

### 3) PRINTER TEST

① Key operation

102 → CA/AT

② Test procedure

OP display

R	/	J		P	R	I	N	T	E	R		S	R	V	

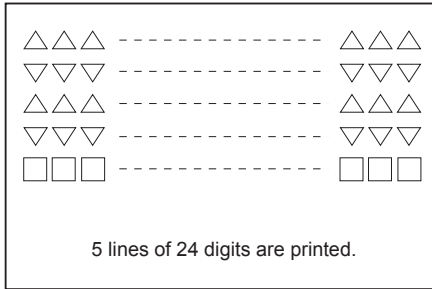

At the receipt side, the logo is also printed and the receipt is issued.

③ Check that:

The print is free from contamination, blur, and uneven density.

④ End of testing

The test will end automatically.

### 4) KEYBOARD TEST

① Key operation

\_\_\_104 → CA/AT



KEY check sum code

② Test procedure

The keyboard is checked using the sum check code of the key code.

If the sum check code is not entered, the check is made using the sum check code of the default keyboard arrangement

The sum check data for each model is entered to the front 4 digits of the DIAG code, and that data is compared with the key data added until the final key (CA/AT) is pressed.

Both data are the same, the test ends, printing the number given below.

If both data are different, the printer prints the error message.

OP display

K	E	Y		B	O	A	R	D			S	R	V	
1	0	4												

KEY CODE

③ Check:

A) The content of completion print

④ End of testing

When the test ends normally: **1 0 4**

When an error occurs: E ~ ~ **1 0 4**

Note: Calculation of key sum check data

Hard codes (hexadecimal number) at the position (excluding feed key) where there is an input data contact are added.

However, the end key (TL) is not added.

This data to which hard codes have been added is converted into a decimal number value, which will become the sum check data that will be entered when DIAG is started.

### 5) MODE SWITCH TEST

① Key operation

105 → CA/AT

② Test procedure

OP display

M	O	D	E		S	W						S	R	V	
1	0	5													X

MODE: SRV\_PGM2\_PGM1\_OFF\_OP X/Z\_REG\_MGR\_X1/Z1\_X2/Z2\_\_SRV  
X : 0 1 2 9 3 4 5 6 7 0

The above X must be read in the correct order. (If the contact is open, 9 will be displayed.)

③ Check:

The display during testing and the content of the completion print.

④ End of testing

When the test ends normally **1 0 5**

When an error occurs: E ~ ~ **1 0 5**

### 6) PRINTER SENSOR TEST

① Key operation

106 → CA/AT

② Test procedure

Check the status of the paper end sensor and head up sensor.

OP display

R	/	J		S	E	N	S	O	R			S	R	V	
1	0	6											X	-	Y

③ Check the following.

X: 1 - Paper present at the receipt side

O - No paper at the receipt side

Y: 1 - Paper present at the journal side

O - No paper at the journal side

④ End of testing

You can exit the test mode by pressing any key and the printer prints the following.

**1 0 6**

### 7) CLOCK TEST

① Key operation

107 → CA/AT

② Test procedure

OP display

T	I	M	E	R	C	H	E	C	K	S	R	V	
1	0	7			*	*	-	*	*	*	*	*	*

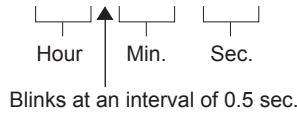

③ Check that:

“-“ blinks and the clock counts up.

④ End of testing

When any key is pressed, the date and time are printed and the test mode will be terminated.

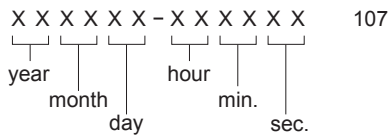

### 8) DRAWER 1 OPEN & SENSOR TEST

① Key operation

110 → CA/AT

② Test procedure

OP display

D	R	A	W	E	R	1				S	R	V	
													X

X : O = DRAWER OPENED  
C = DRAWER CLOSED

③ Check that:

A) **That** drawer 1 opens normally.

B) The sensor correctly indicates the status of the drawer 1.

④ End of testing

You can exit the test mode by pressing any key. The printer prints the following.

1 1 0

### 9) DRAWER 2 OPEN & SENSOR TEST

① Key operation

111 → CA/AT

② Test procedure

OP display

D	R	A	W	E	R	2				S	R	V	
													X

X : O = DRAWER OPENED  
C = DRAWER CLOSED

③ Check that:

A) **That** drawer 2 opens normally.

B) The sensor correctly indicates the status of the drawer 2.

④ End of testing

You can exit the test mode by pressing any key. The printer prints the following.

1 1 1

### 10) LCD CG TEST

① Key operation

116 → CA/AT

② Test procedure

To check the display CG, 256 pieces of built-in CG's are grouped into 16 blocks and each 16 characters is displayed on the dot display.

At first, CG code of 00H ~ 0FH is displayed. By pressing any key, each block is displayed in sequence.

OP display

X	Y									S	R	V	
○	○	○	○	○	○	○	○	○	○	○	○	○	○

"O" indicates the CG display position.

"XY" indicates the code at the head of each block in hexadecimal number.  
(Example: 10, A0)

③ Check that:

A) Displays are clear.

B) Free from blur, chip-off, unevenness.

④ End of testing

You can exit the test mode by pressing any key. The printer prints the following.

1 1 6

## 11) STANDARD RAM TEST

① Key operation

120 → 

CA/AT
-------

② The standard RAM is checked.

The contents of memory must be the same before and after this test.

RAM (100000H~1FFFFFFH area) is tested in the following procedure:

- a) Store data in the test areas
- b) Write "00H"
- c) Read and compare "00H" and then write "55H"
- d) Read and compare "55H" and then write "AAH"
- e) Read and compare "AAH"
- f) Restore stored data

If an error occurs at a step, the error is printed.

If an error does not occur, the following addresses are checked in turns.

Addresses to be checked:

300000H, 300001H, 300002H, 300004H, 300008H, 300010H,  
 300020H, 300040H, 300080H, 300100H, 300200H, 300400H,  
 300800H, 301000H, 302000H, 304000H, 308000H, 310000H,  
 320000H, 340000H, 380000H,

OP display

R	A	M											S	R	V
1	2	0													

③ Check: A) The completion print.

④ End of testing

The program ends after printing as follows:

When the test ends normally: **1 2 0**

When the test end abnormally: Ex ~ ~ ~ **1 2 0**

\*\*\*\*\*

x = 1: Data error

x = 2: Address error

When an error occurs, an error message is printed and the address where the error has occurred in the area \*\*\*\*\*.

## 12) OPTION RAM TEST

① Key operation

121 → 

CA/AT
-------

② The standard RAM is checked.

The test program tests internal RAM (10 Kbytes) of the CPU.

The contents of memory must be stored before and after this test.

RAM (00400H ~ 02BFFH area) is tested in the following procedure.

- a) Store data in the test area.
- b) Write "00H"
- c) Read and compare "00H" and then write "55H"
- d) Read and compare "55H" and then write "AAH"
- e) Read and compare "AAH"
- f) Restore stored data

If an error occurs at a step, the error is printed.

If an error does not occur, the following addresses are checked in turns.

Addresses to be checked:

400000H, 400001H, 400002H, 400004H, 400008H, 400010H,  
 400020H, 400040H, 400080H, 400100H, 400200H, 400400H,  
 400800H, 401000H, 402000H, 404000H, 408000H, 410000H,  
 420000H, 440000H, 480000H, 500000H,

OP display

C	P	U											S	R	V
1	2	1													

③ Check: The completion print.

④ End of testing

The test program ends after printing.

When the test ends normally: **1 2 1**

When the test ends abnormally: Ex ~ ~ ~ **1 2 1**

\*\*\*\*\*

x = 1: Data error

x = 2: Address error

If an error occurs, an error message is printed and the address where the error has occurred in the area \*\*\*\*\*.



Data communication check

A loopback test of 256-byte data between is performed.

DATA: \$00 - \$FF BAUD RATE:9600 BPS

OP display

R	S	2	3	2		T	E	S	T	S	R	V	
5	0	0											

③ Check:

The completion print.

④ End of testing

Completion print	RS TEST	OK
Error print	RS TEST	**NG**ERxx
xx	Contents of error	
01	ER DR error	
02	ER CI error	
03	RS CD error	
04	RS CD error	
05	DATA error	
06	DATA error	DATA error/framing error

18) RS232 CH2 TEST

Install the RS232 loopback connector.

① Key operation

501 → CA/AT

② Test procedure

The test program checks the control signals.

OUTPUT		INPUT			
/ER2	/RS2	/DR2	/CI2	/CD2	/CS2
OFF	OFF	OFF	OFF	OFF	OFF
OFF	ON	OFF	OFF	ON	ON
ON	OFF	ON	ON	OFF	OFF
ON	ON	ON	ON	ON	ON

Data communication check

A loopback test of 256-byte data between is performed.

DATA: \$00 - \$FF BAUD RATE: 9600 BPS

OP display

R	S	2	3	2		T	E	S	T	S	R	V	
5	0	1											

③ Check:

The completion print.

④ End of testing

Completion print	RS TEST	OK
Error print	RS TEST	**NG**ERxx
xx	Contents of error	
01	ER DR error	
02	ER CI error	
03	RS CD error	
04	RS CD error	
05	DATA error	
06	DATA error	DATA error/framing error

19) SCANNER TEST

The bar code data read from the scanner is displayed and printed.

① Key operation

510 → CA/AT

② Test procedure

The bar code scanner is tested while connected with RS-232 PORT of ERA520, ER-A530.

Scanner initialization command "R" is transmitted, Tsu Te reading beginning command "E" is transmitted, and reading the scanner is begun. When data is read, data except STX and CR are displayed and the receipt is printed. Whenever read and updated, the output is updated.

OP display

S	C	A	N	N	E	R					S	R	V	
*	*	*	*	*	*	*	*	*	*	*	*	*	*	*

The read data is displayed on the left.

Receipt printing:

The data is read from the scanner and then displayed and printed

③ Check: Check whether the data read is correct.

④ End of testing

You can exit the test mode by pressing any key. The printer prints the following.

5 1 0

# CHAPTER 6. IPL FROM EP-ROM

Before installation, unplug the AC power cord from the AC outlet.

1. Open the top cabinet.
2. Set the IPL switch (S1) to the ROM COPY position.

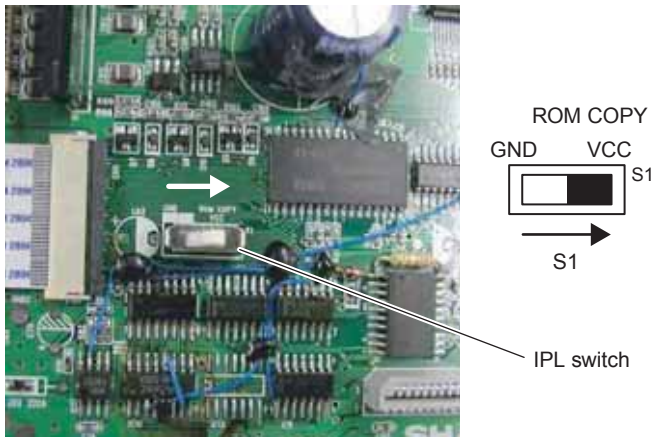

6. Unplug the AC power cord from the AC outlet.
7. Remove the IPL ROM from the IC socket of the MAIN PWB.
8. Set the IPL switch (S1) to GND position.

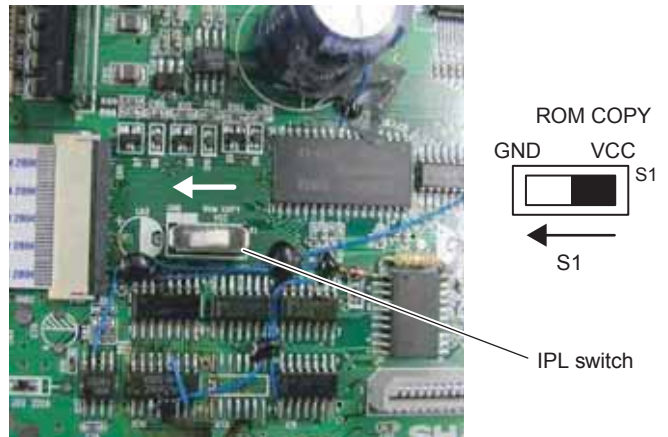

3. Install the IPL ROM in the IC socket of the MAIN PWB.

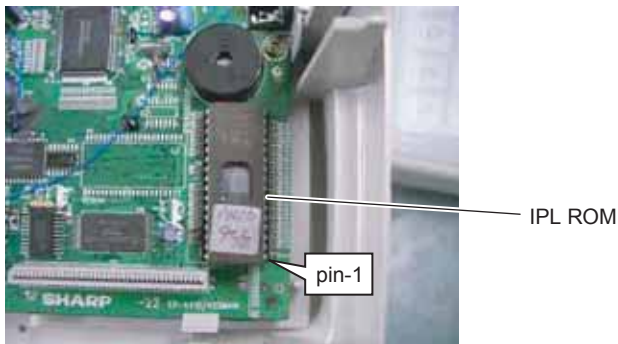

9. Replace the top cabinet.
10. Perform a master reset.

Turn the mode key switch to the SRV' position, insert the AC power cord into the AC outlet. While holding down the Journal feed key, turn the mode key from the SRV position to the SRV' position.

4. Turn the mode key switch to SRV' position, and insert the AC power cord into the AC outlet.
5. Turn the mode key switch to SRV position. The IPL procedure is started.



When the procedure is completed, the message of "Completed" is shown.



# CHAPTER 7. CIRCUIT DIAGRAM AND PWB LAYOUT

## CPU

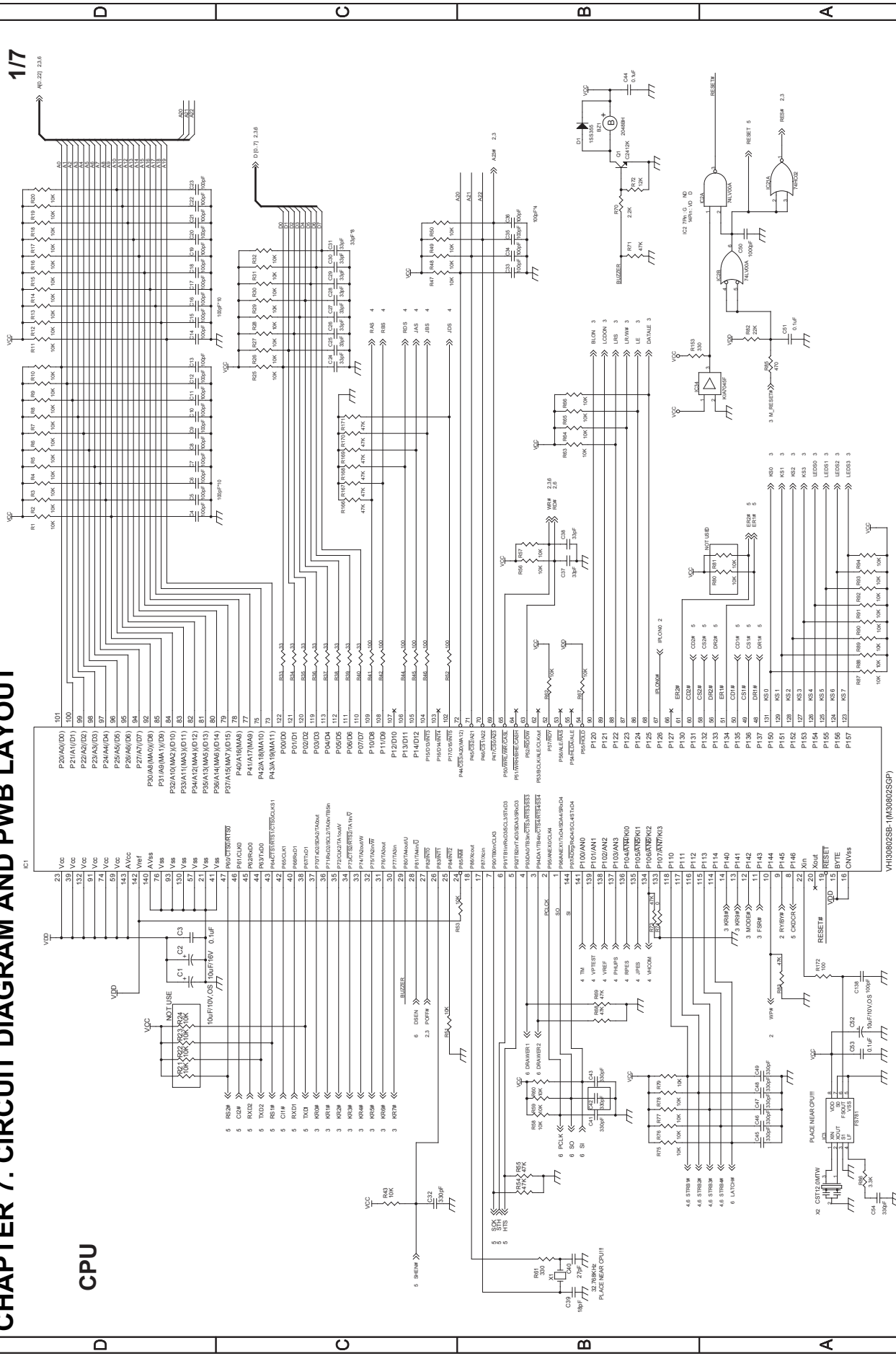

# SRAM / FROM / EPROM / POFF

2/17

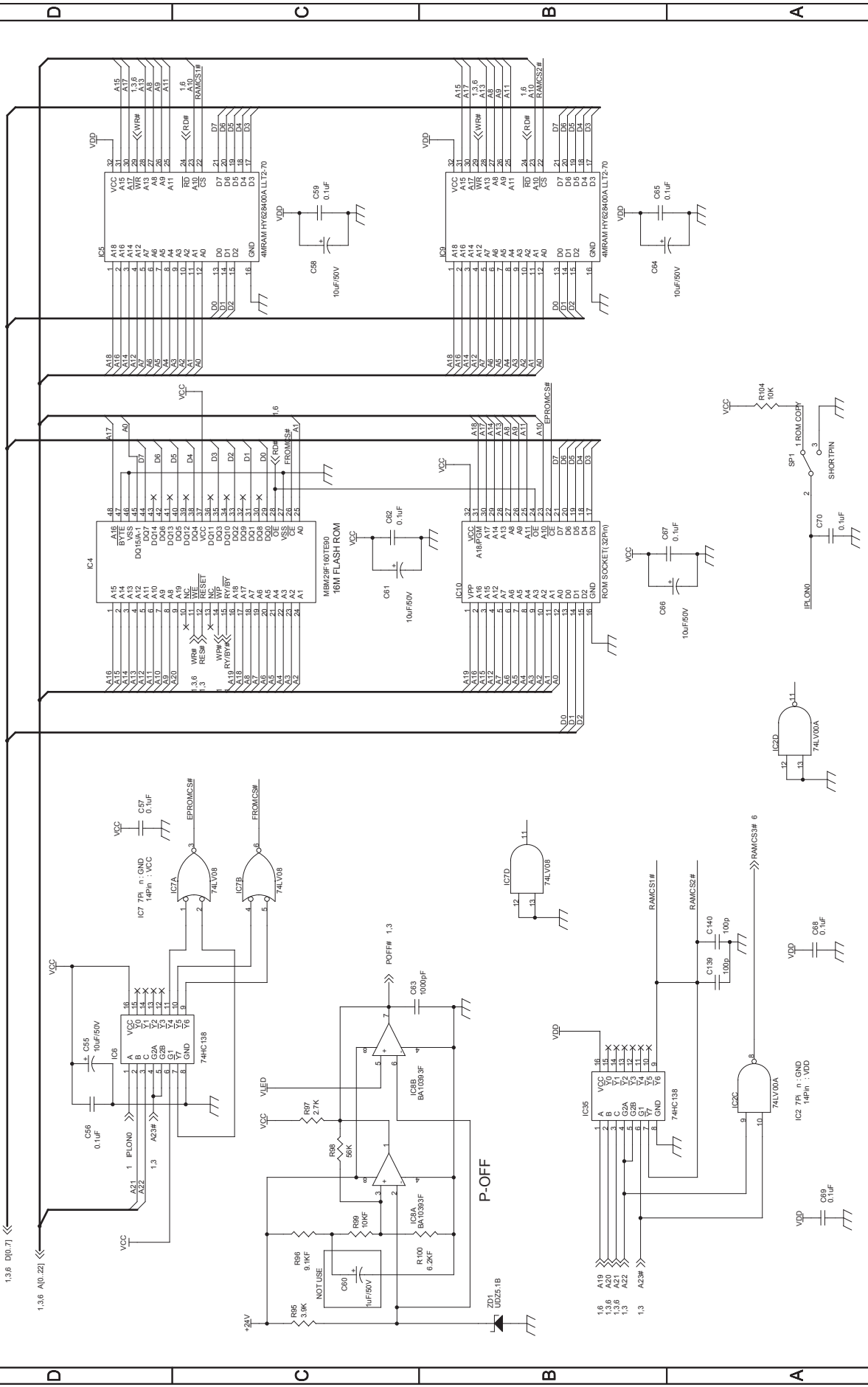







OPTION RAM CONNECTOR / PRINTER CONNECTOR / DRAWER

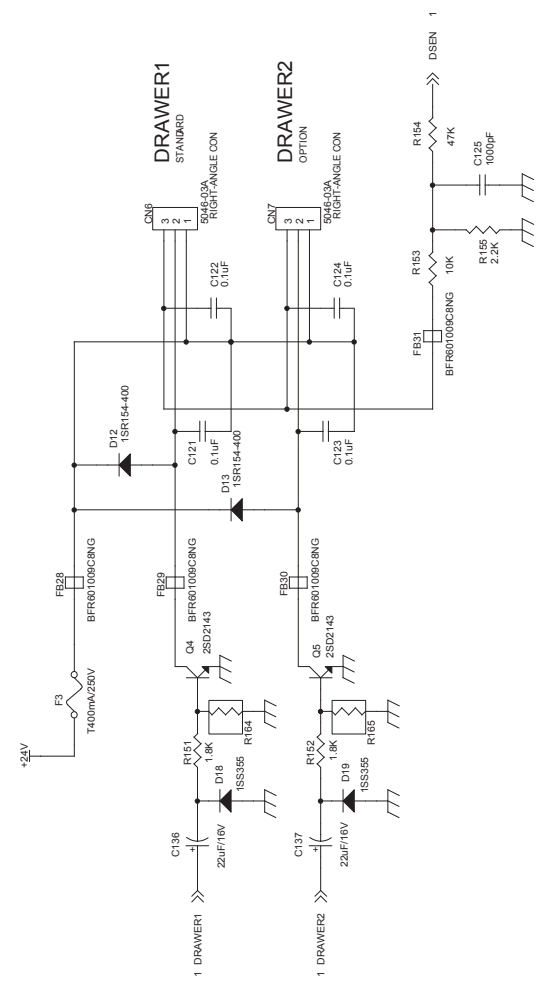
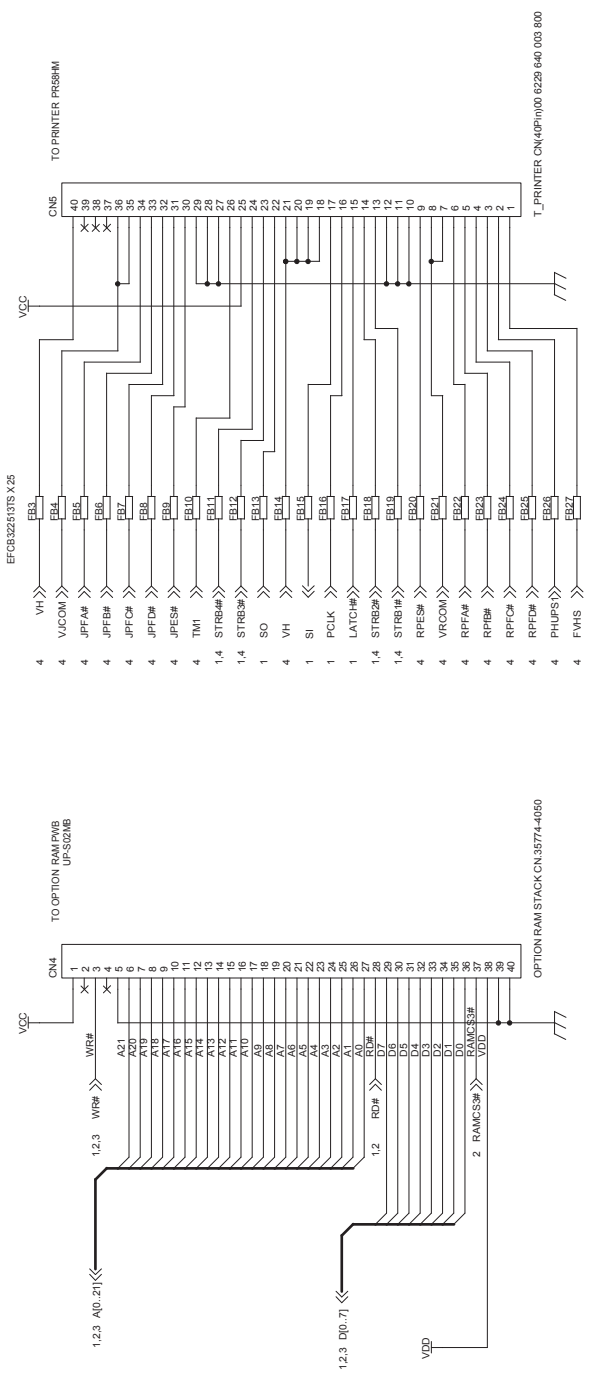

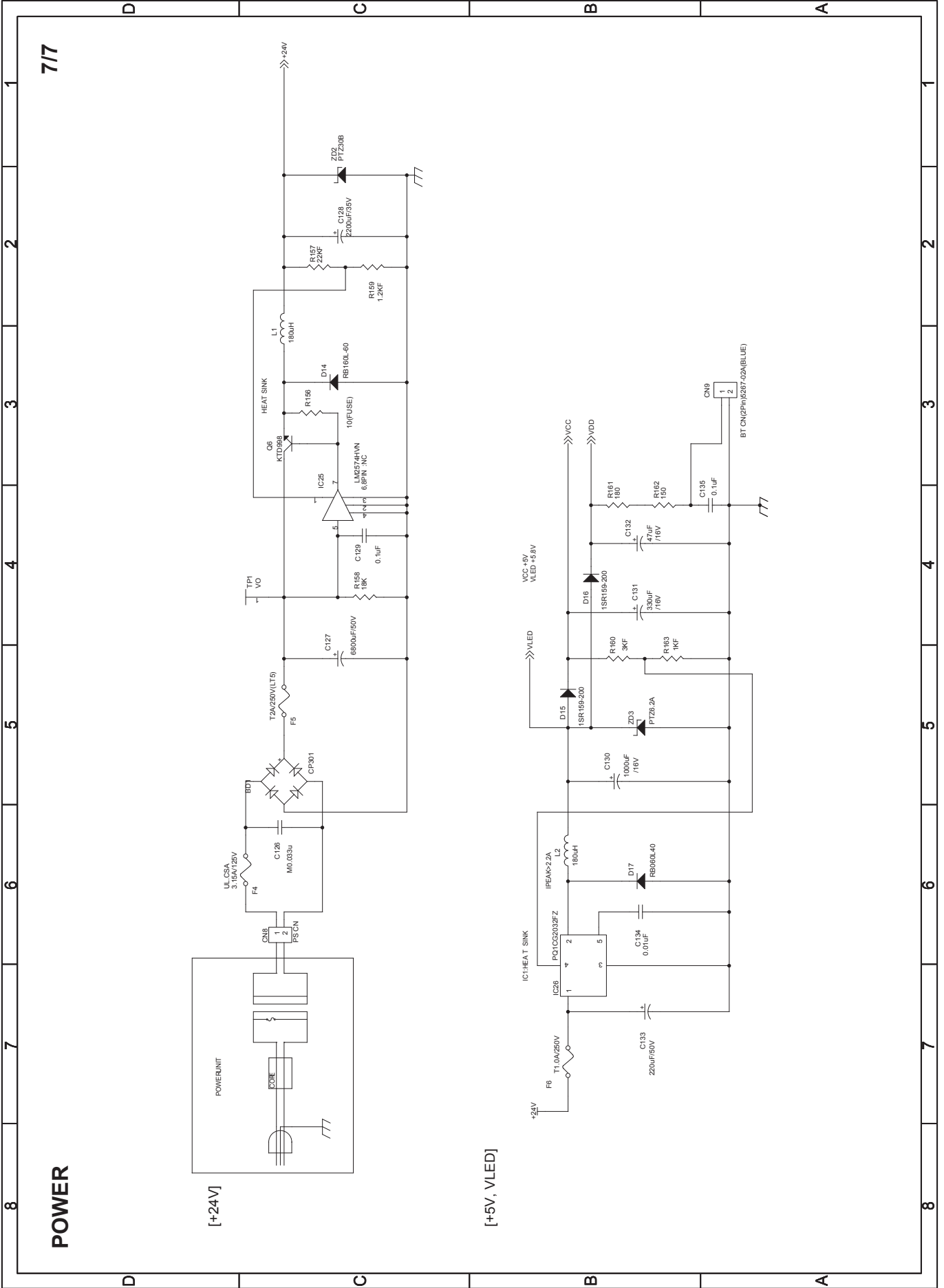

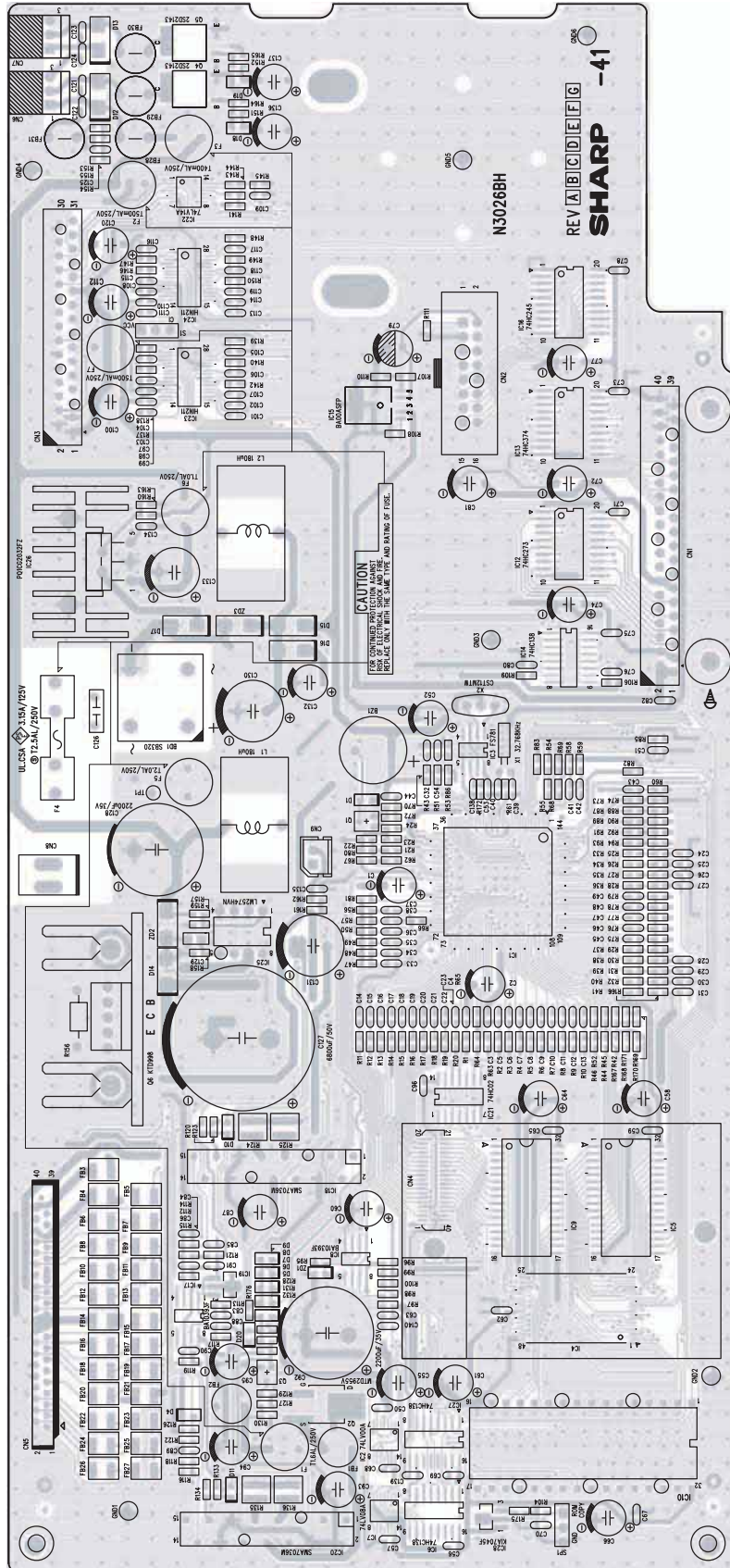

ER-A520U/ER-A530U CIRCUIT DIAGRAM AND PWB LAYOUT

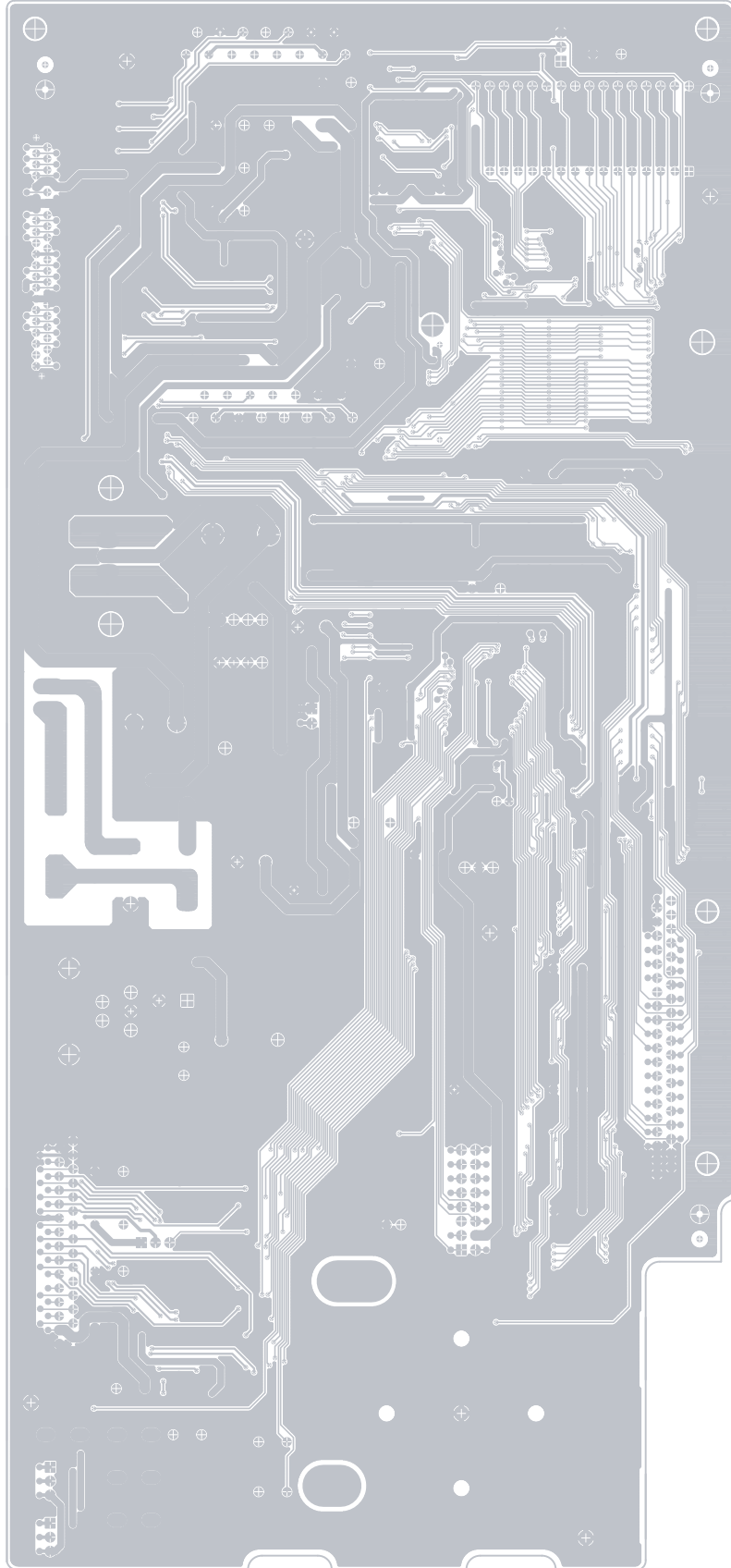

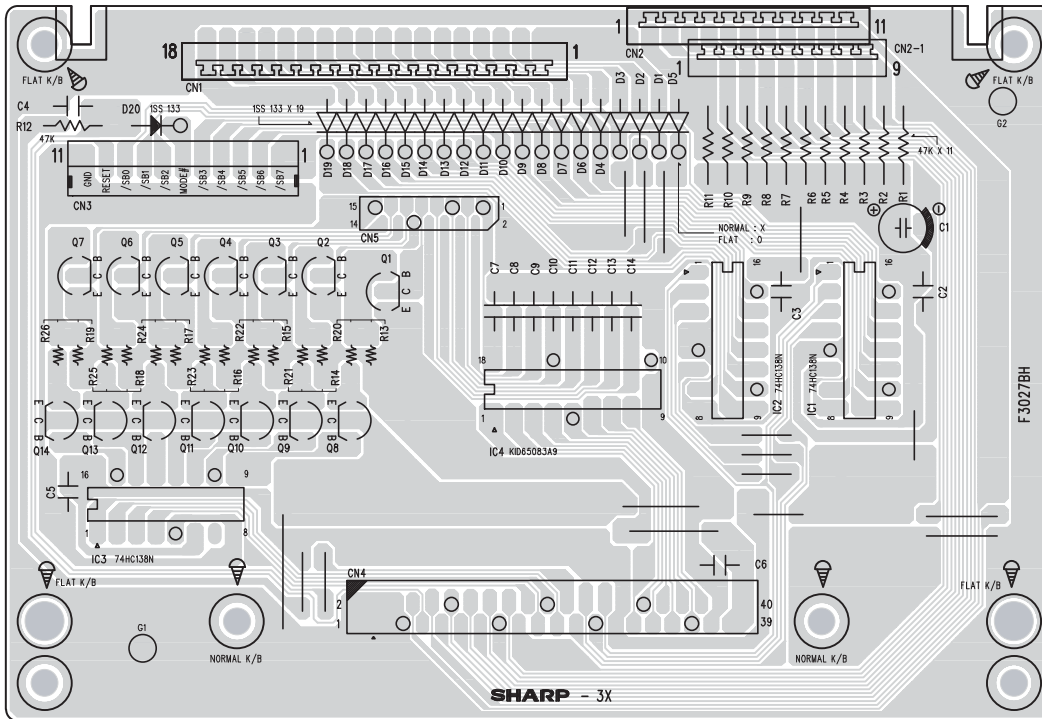
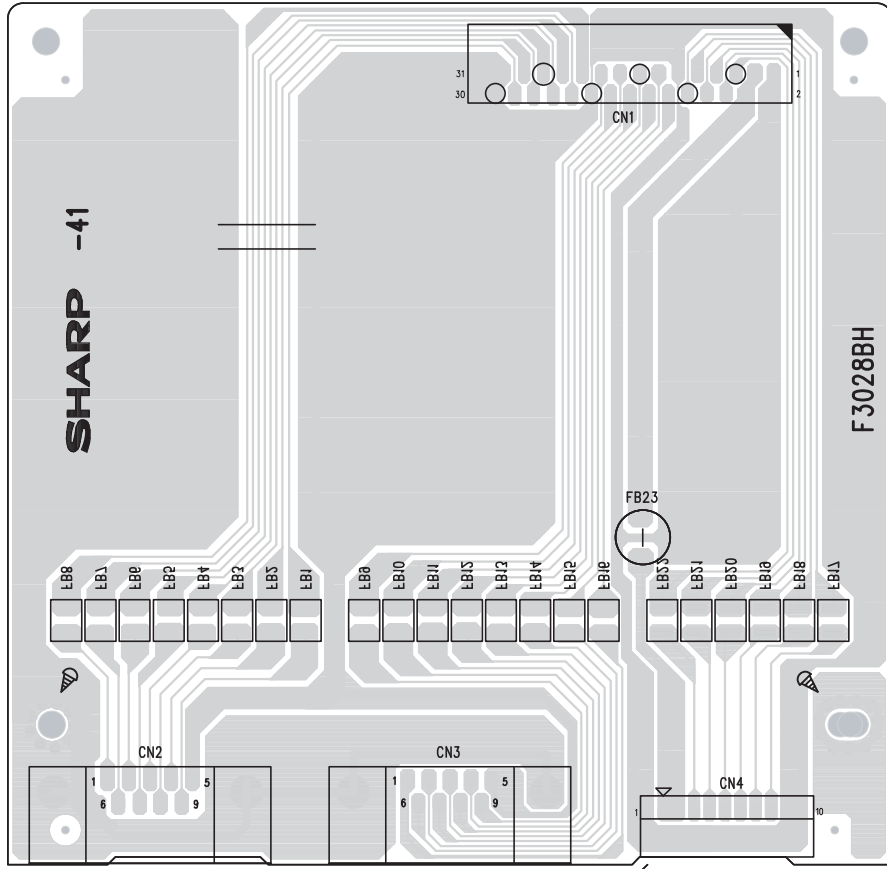

# SHARP

**COPYRIGHT © 2004 BY SHARP CORPORATION**

All rights reserved.

Printed in Japan.

No part of this publication may be reproduced,  
stored in a retrieval system, or transmitted.

In any form or by any means,  
electronic, mechanical, photocopying, recording, or otherwise,  
without prior written permission of the publisher.

**SHARP CORPORATION**  
**Digital Document Systems Group**  
**Products Quality Assurance Department**  
**Yamatokoriyama, Nara 639-1186, Japan**

2004 March Printed in Japan ⓘ